

# NEW COLLECTION



ART



LOTUS 2



KAYLA



SARA



VEGA

# ART

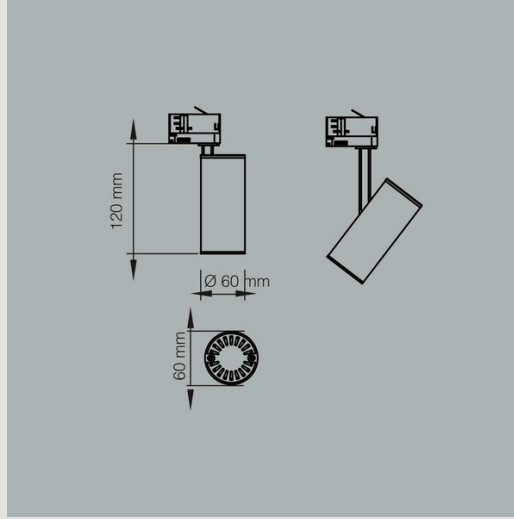

Metal coated body  
 Electrostatic powder paint & varnish coated  
 Main Voltage 220-240V 50-60 Hz  
 3 & 5 phase tracks adaptors available



# NOVA

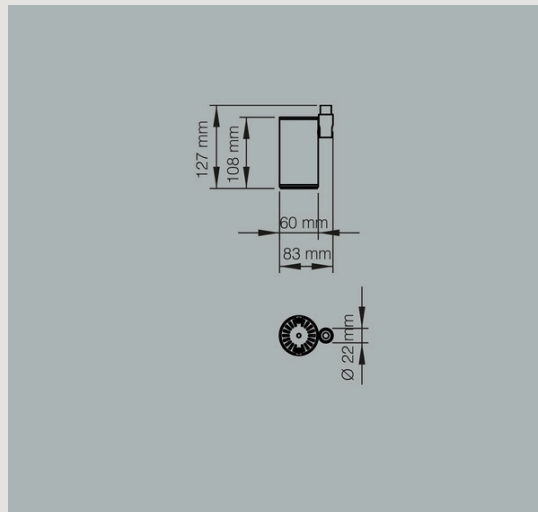

Metal coated body  
 Electrostatic powder paint & varnish coated  
 Main Voltage 220-240V 50-60 Hz  
 3 & 5 phase tracks adaptors available



## TUNA

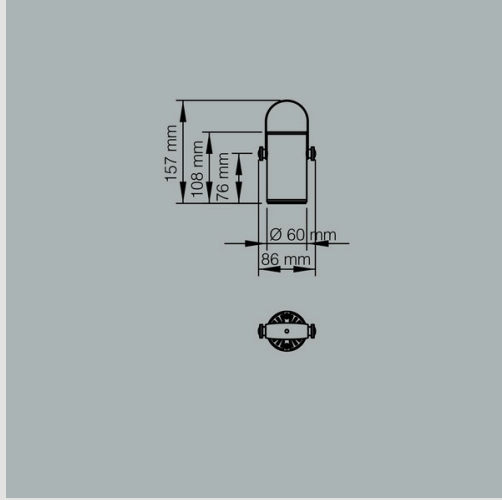

Metal coated body

Electrostatic powder paint & varnish coated

Main Voltage 220-240V 50-60 Hz

3 & 5 phase tracks adaptors available



## TUNA- R

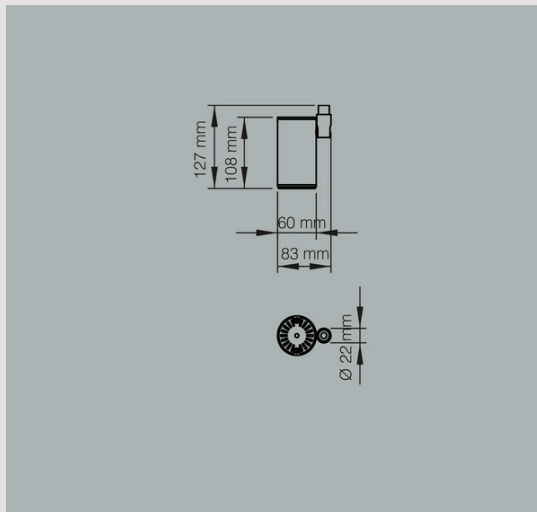

Metal coated body

Electrostatic powder paint & varnish coated

Main Voltage 220-240V 50-60 Hz

Ceiling base for surface instalation

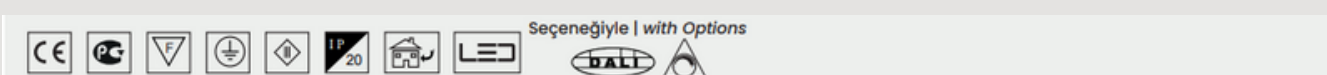

## ZARA 2.3

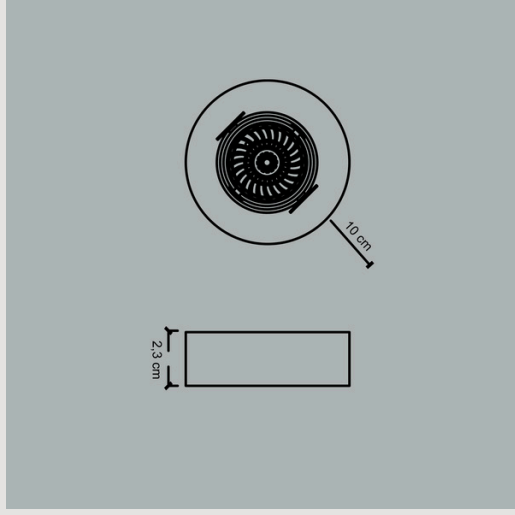
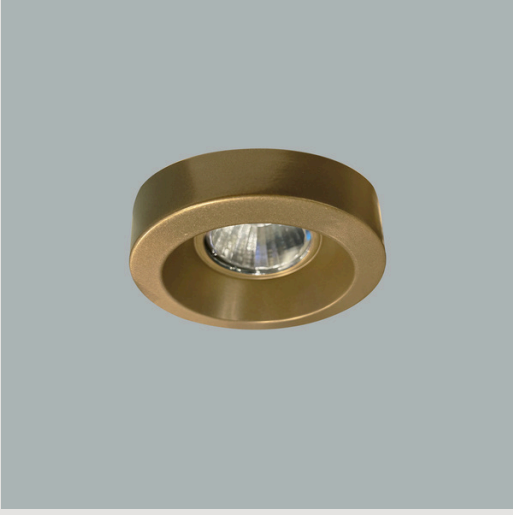

Metal coated body

Electrostatic powder paint & varnish coated

Main Voltage 220-240V 50-60 Hz

Ceiling base for surface instalation



## ZARA 3.4

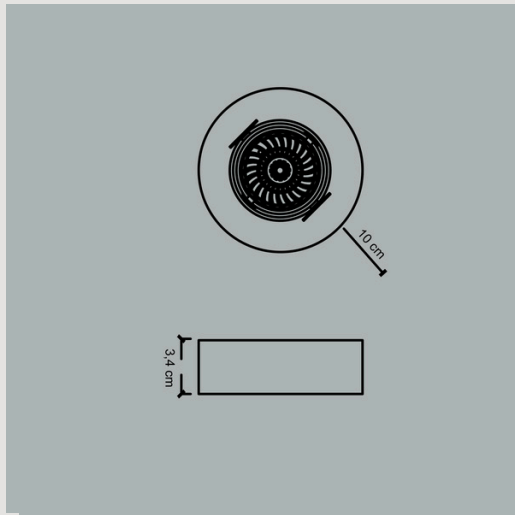

Metal coated body

Electrostatic powder paint & varnish coated

Main Voltage 220-240V 50-60 Hz

Ceiling base for surface instalation



## SARA

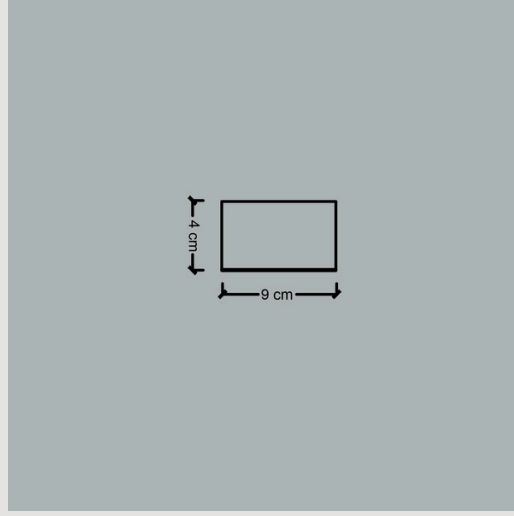

Metal coated body

Electrostatic powder paint & varnish coated

Main Voltage 220-240V 50-60 Hz

Ceiling base for surface instalation



## ERA

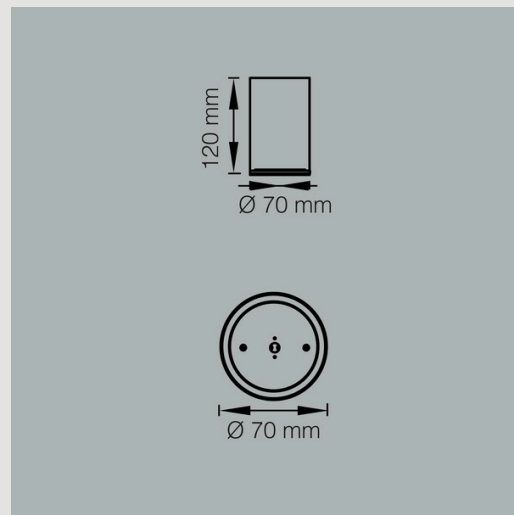

Metal coated body

Electrostatic powder paint & varnish coated

Main Voltage 220-240V 50-60 Hz

Ceiling base for surface instalation



## ARYA -1

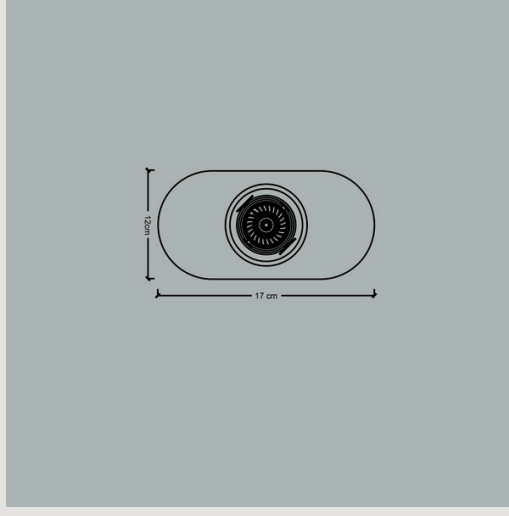

Metal coated body

Electrostatic powder paint & varnish coated

Main Voltage 220-240V 50-60 Hz

Recessed lighting armature for gypsum ceiling



## ARYA -2

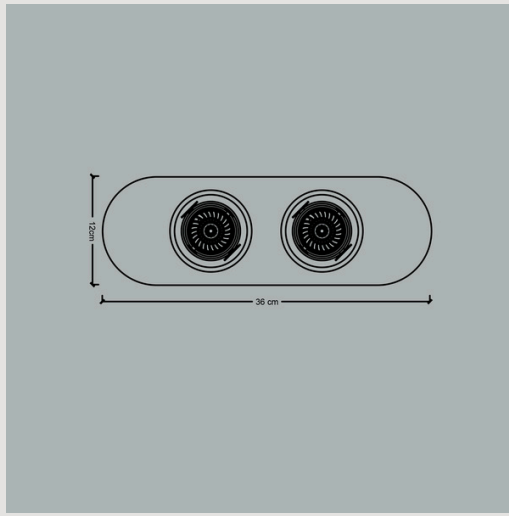

Metal coated body

Electrostatic powder paint & varnish coated

Main Voltage 220-240V 50-60 Hz

Recessed lighting armature for gypsum ceiling



## VEGA

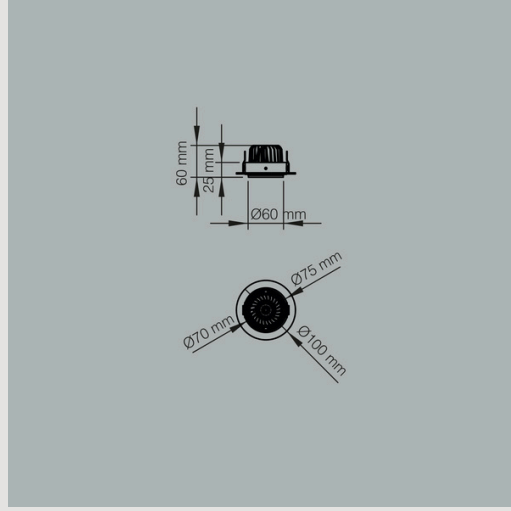
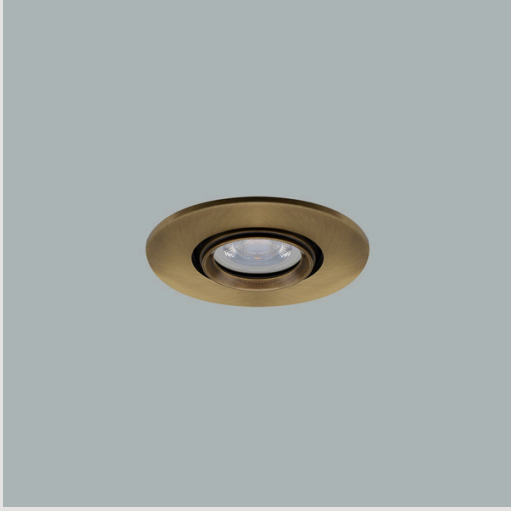

Metal coated body

Electrostatic powder paint & varnish coated

Main Voltage 220-240V 50-60 Hz

Recessed lighting armature for gypsum ceiling



## KAYLA

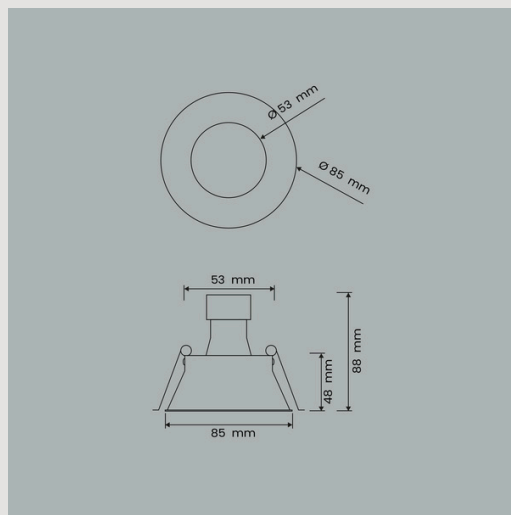

Metal coated body

Electrostatic powder paint & varnish coated

Main Voltage 220-240V 50-60 Hz

Recessed lighting armature for gypsum ceiling



## LOTUS 1

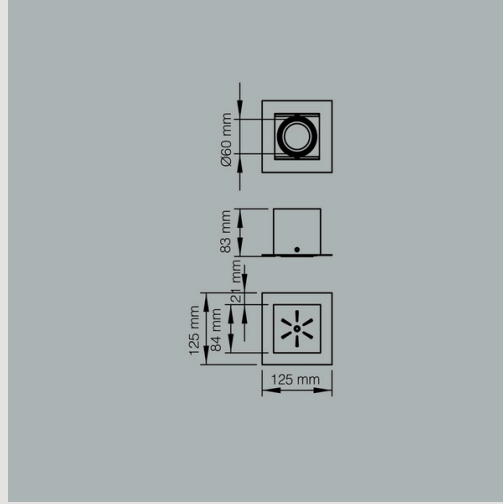

Metal coated body

Electrostatic powder paint & varnish coated

Main Voltage 220-240V 50-60 Hz

Recessed lighting armature for gypsum ceiling



## LOTUS 2

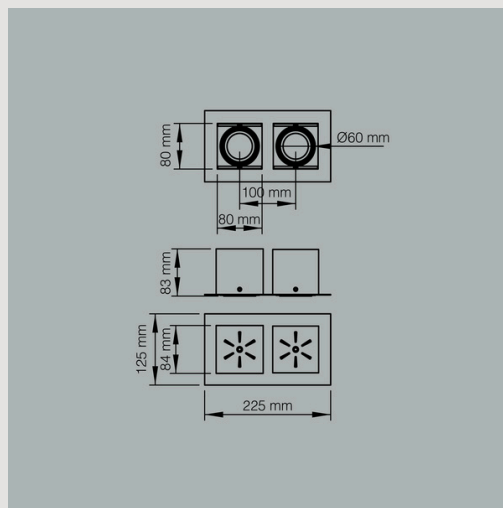

Metal coated body

Electrostatic powder paint & varnish coated

Main Voltage 220-240V 50-60 Hz

Recessed lighting armature for gypsum ceiling



Visit web site to see all range:  
[www.nazolux.com](http://www.nazolux.com)



For all inquiries please contact us  
e-mail:  
[info@nazolux.com](mailto:info@nazolux.com)  
[export@nazolux.com](mailto:export@nazolux.com)

